

IP/IPX Series Backplane

Supports PCI and ISA slot on one backplane!
For half-sized PCISA series single board computers

The advantages of using the PCISA card series are numerous:

1. Supports standard PISA version 1.0 slot on the IP/IPX series passive backplane.
2. Compatible with all available PCI/ISA cards. IP/IPX backplane is also integrated with the PCISA series card slot.

Selection Guide

 PAC series wall-mount chassis

 4U rack-mount chassis

Model	IP-3S-RS	IP-3S2-RS	IP-3SA-RS	IP-4S-RS	IP-4S2-RS	IP-4S2A-RS	IP-4S3-RS
Total Slot	3	3	3	4	4	4	4
PCI Slot	2	1	2	3	2	3	
ISA Slot					1		3
PSU Type	AT	AT	ATX	AT	AT	ATX	AT
Chassis	PAC-53GH PR-1300G	PAC-53GH PR-1300G	PR-1300G	PAC-400G PAC-42GH	PAC-400G PAC-42GH	PAC-400G	PAC-400G PAC-42GH



Model	IP-4S4-RS	IP-4SA-RS	IP-5S2-RS	IP-5SA-RS	IP-5SA2-RS	IP-6S-RS	IP-6SA-RS
Total Slot	4	4	5	5	5	6	6
PCI Slot		3	4	3	4	3	3
ISA Slot	3			1		2	2
PSU Type	AT	ATX	AT	ATX	ATX	AT	ATX
Chassis	PAC-400G PAC-42GH	PAC-400G PAC-42GH	PR-1500G	PR-1500G	PR-1500G	PAC-107G PAC-1000G	PAC-106G PAC-107G PAC-1000G

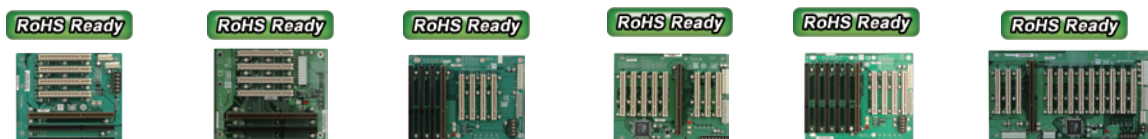

Model	IP-7S-RS	IP-7SA-RS	IP-8S-RS	IPX-9S-RS	IP-10S-RS	IPX-13S-RS
Total Slot	7	7	8	9	10	13
PCI Slot	4	4	4	8	4	12
ISA Slot	2	2	3		5	
PSU Type	AT	ATX	ATX/AT	ATX/AT	ATX/AT	ATX/AT
Chassis	PAC-700G PAC-1700G	PAC-700G PAC-1700G	PAC-125G RACK-3400G	PAC-125G RACK-3400G	PAC-125G RACK-3400G	RACK-305G RACK-360G RACK-3000G

IP-3S-RS-R40

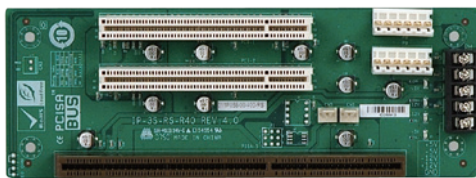

Ordering Information

IP-3S-RS-R40	3-slot backplane with 2 PCI slots
PAC-53GH	3-slot half-size compact chassis
PR-1300G	3-slot half-size compact chassis

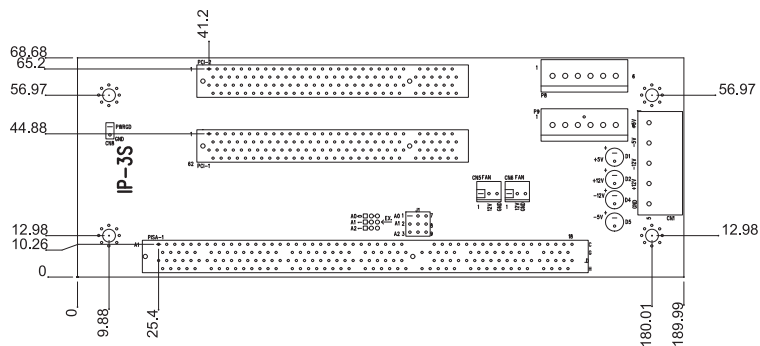

IP-3S2-RS-R40

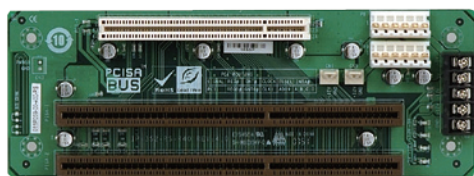

Ordering Information

IP-3S2-RS-R40	3-slot backplane with 1 PCI slot
PAC-53GH	3-slot half-size compact chassis
PR-1300G	3-slot half-size compact chassis

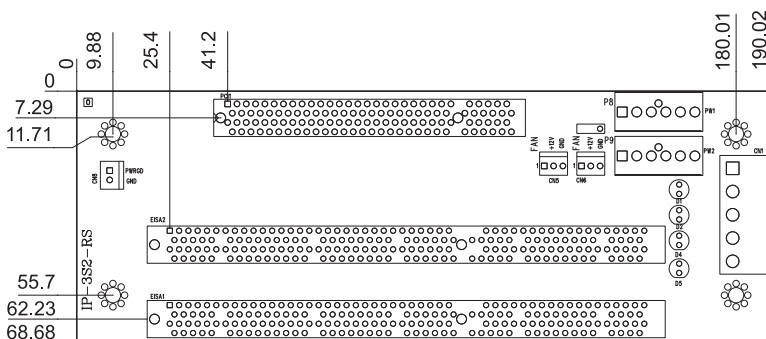

IP-3SA-RS-R40

ATX power

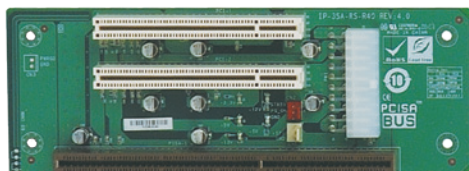

Ordering Information

IP-3SA-RS-R40	3-slot backplane with 2 PCI slots
PR-1300G	3-slot half-size compact chassis

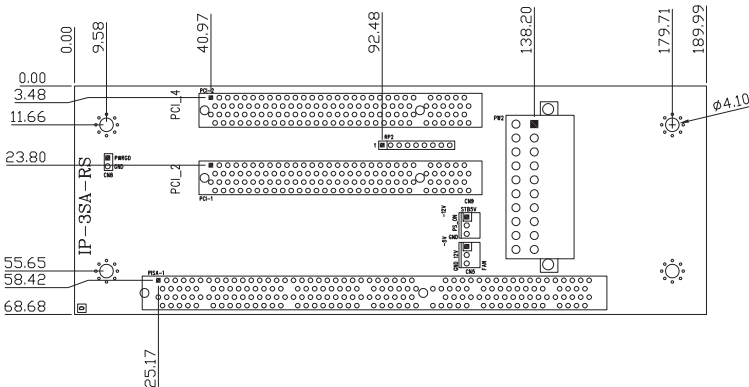

IP-4S-RS-R40

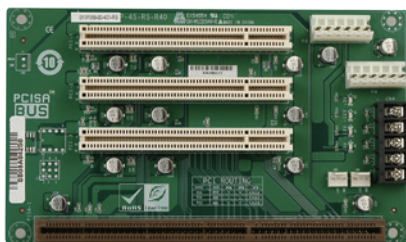

Ordering Information

IP-4S-RS-R40	4-slot backplane with 3 PCI slots
PAC-400G	4-slot half-size compact chassis
PAC-42GH	4-slot half-size compact chassis

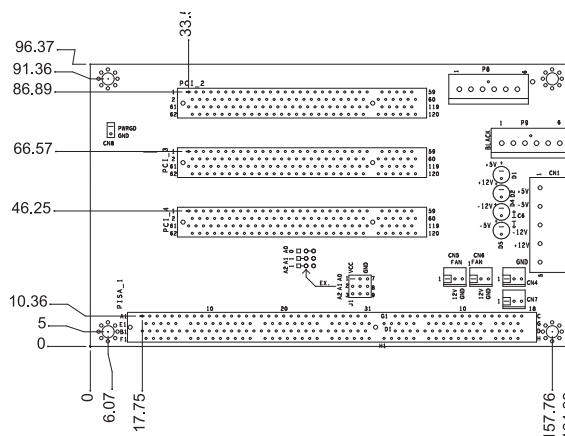

IP-4S2-RS-R40



Ordering Information

IP-4S2-RS-R40	4-slot backplane with 2 PCI slots and 1 ISA slot
PAC-400G	4-slot half-size compact chassis
PAC-42GH	4-slot half-size compact chassis

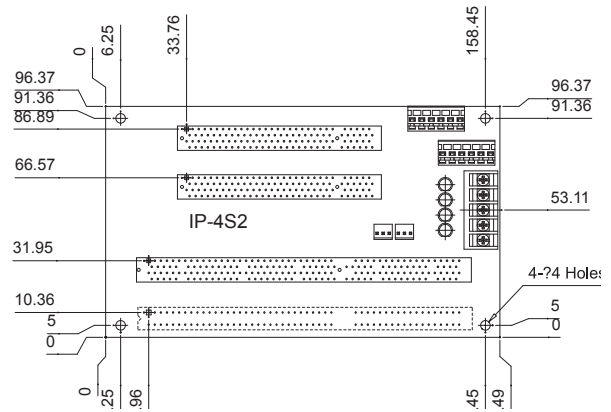

IP-4S2A-RS-R40

ATX power

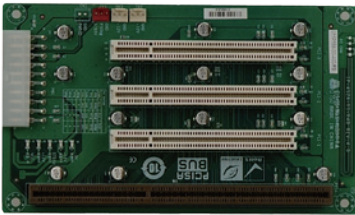

Ordering Information

IP-4S2A-RS-R40	4-slot backplane with 3 PCI slots
PAC-400G	4-slot half-size compact chassis

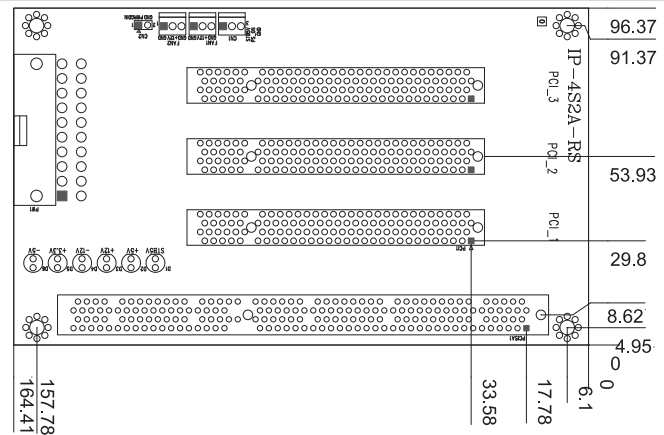

IP-4S3-RS-R40

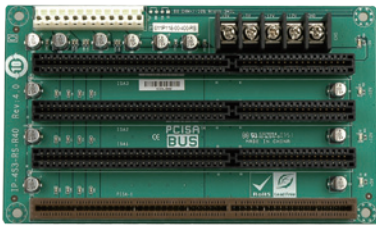

Ordering Information

IP-4S3-RS-R40	4-slot backplane with 3 ISA slots
PAC-400G	4-slot half-size compact chassis
PAC-42GH	4-slot half-size compact chassis

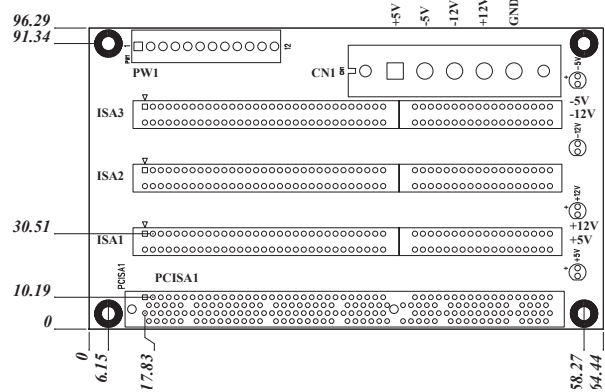

IP-4S4-RS-R40

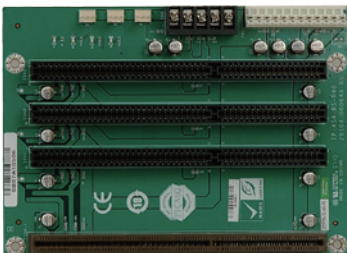

Ordering Information

IP-4S4-RS-R40	4-slot backplane with 3 ISA slots
PAC-400G	4-slot half-size compact chassis
PAC-42GH	4-slot half-size compact chassis

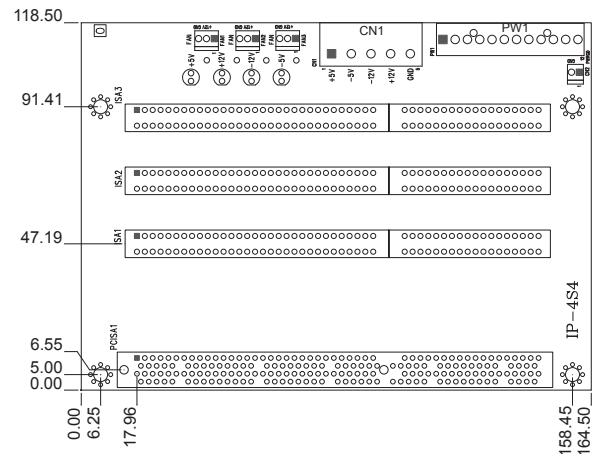

IP-4SA-RS-R40

ATX power

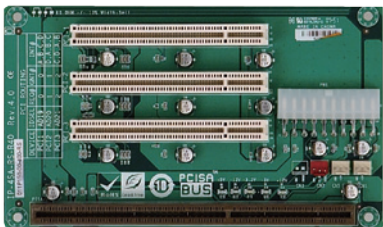

Ordering Information

IP-4SA-RS-R40	4-slot backplane with 3 PCI slots
PAC-400G	4-slot half-size compact chassis
PAC-42GH	4-slot half-size compact chassis

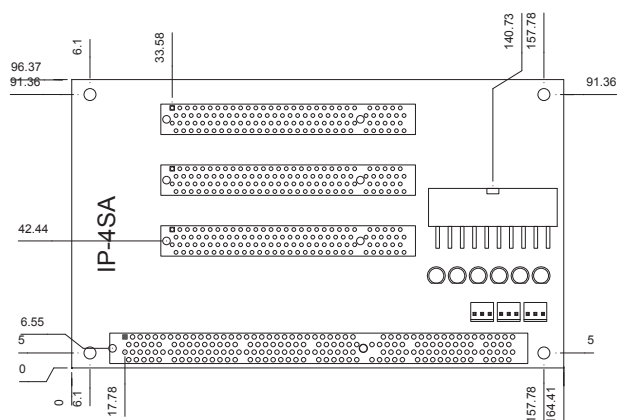

IP-5S2-RS-R40

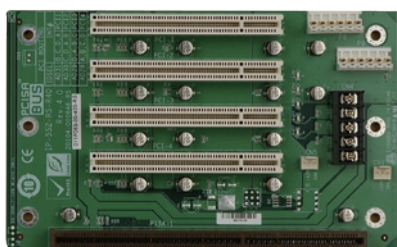

Ordering Information

IP-5S2-RS-R40	5-slot backplane with 4 PCI slots
PR-1500G	5-slot half-size compact chassis



Ordering Information

0	9.88	25.4	41.2	164.8	175.24
---	------	------	------	-------	--------

IP-5SA-RS-R40

ATX power

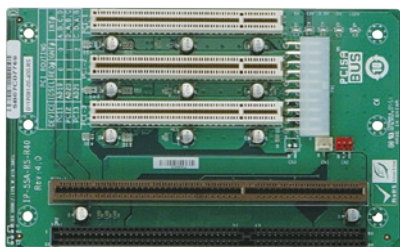

Ordering Information

IP-5SA-RS-R40	5-slot backplane with 3 PCI slots and 1 ISA slot
PR-1500G	5-slot half-size compact chassis

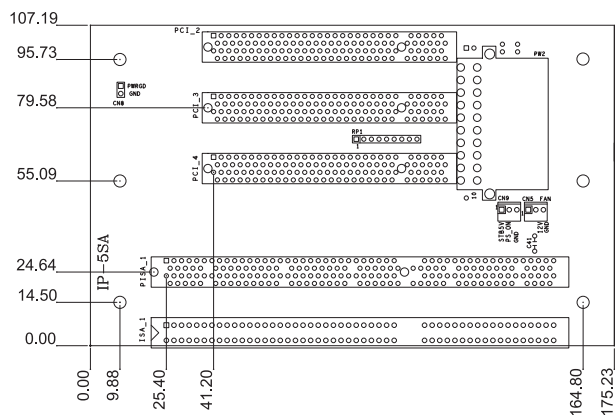

IP-5SA2-RS-R40

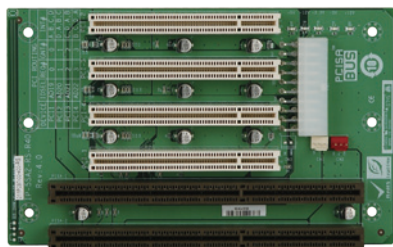

Ordering Information

IP-5SA2-RS-R40	5-slot backplane with 4 PCI slots
PR-1500G	5-slot half-size compact chassis

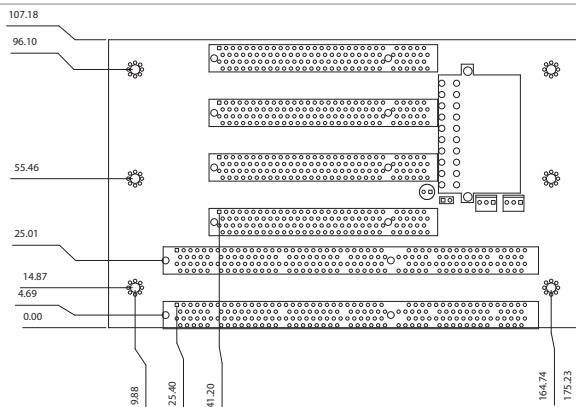

IP-6S-RS-R40

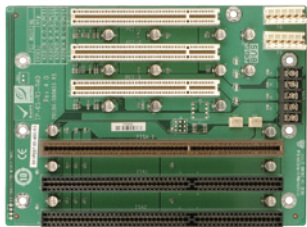

Ordering Information

IP-6S-RS-R40	6-slot backplane with 3 PCI slots and 2 ISA slots
PAC-107G	6-slot full-size compact chassis
PAC-1000G	6-slot full-size compact chassis

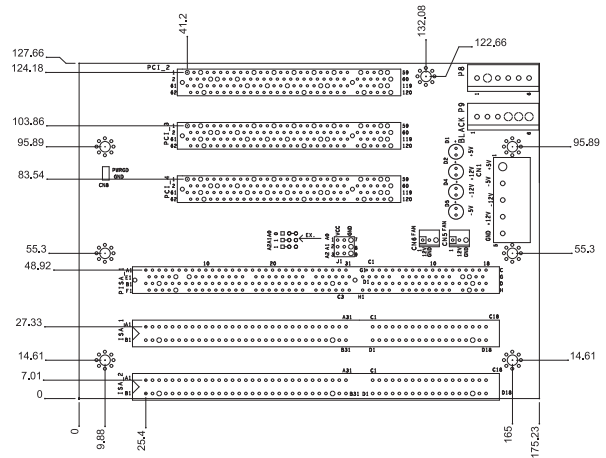

IP-6SA-RS-R40

ATX power

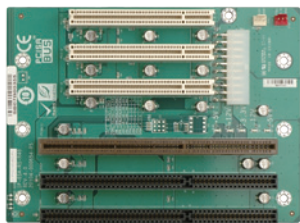

Ordering Information

IP-6SA-RS-R40	6-slot backplane with 3 PCI slots and 2 ISA slots
PAC-106G	6-slot full-size compact chassis
PAC-107G	6-slot full-size compact chassis
PAC-1000G	6-slot full-size compact chassis

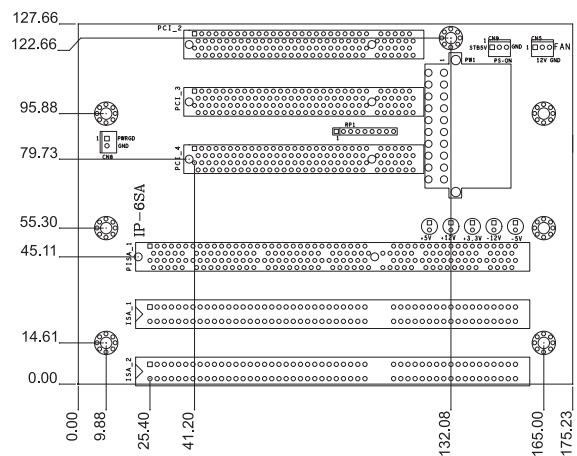

IP-7S-RS-R40



Ordering Information

IP-7S-RS-R40	7-slot backplane with 3 PCI slots and 2 ISA slots
PAC-700G	7-slot half-size compact chassis
PAC-1700G	7-slot half-size compact chassis

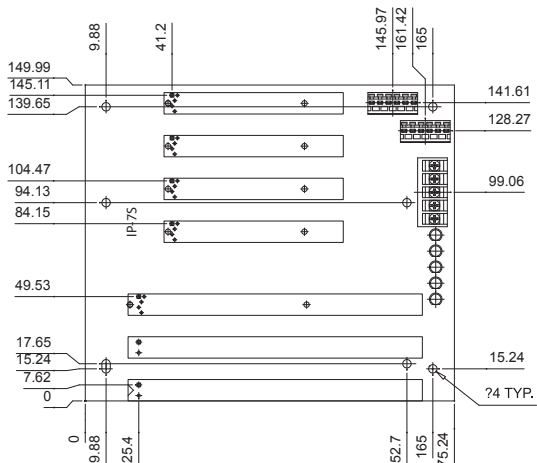

IP-7SA-RS-R40

ATX power

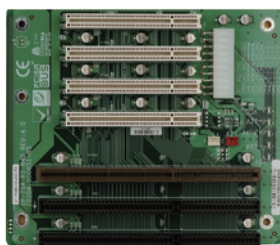

Ordering Information

IP-7SA-RS-R40	7-slot backplane with 3 PCI slots and 2 ISA slots
PAC-700G	7-slot half-size compact chassis
PAC-1700G	7-slot full-size compact chassis

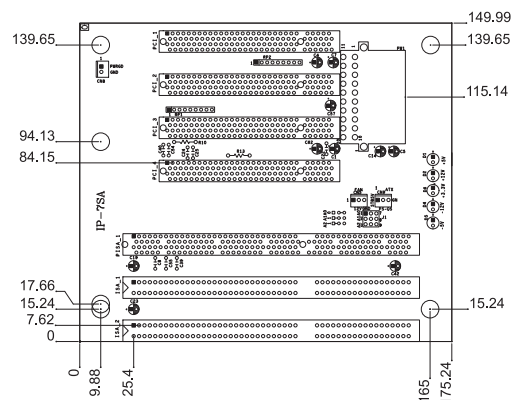

IP-8S-RS-R40

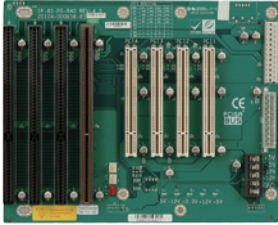

Ordering Information

IP-8S-RS-R40	8-slot backplane with 4 PCI slots and 3 ISA slots
PAC-125G	10-slot full-size compact chassis
RACK-3400G	4U 10-slot half-size rack-mount chassis

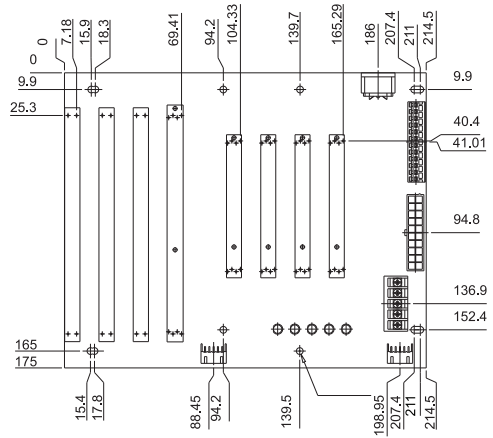

IPX-9S-RS-R41

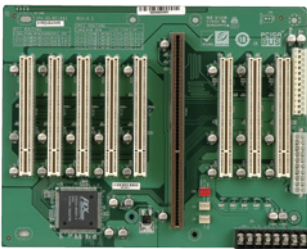

Ordering Information

IPX-9S-RS-R41	9-slot backplane with 8 PCI slots
PAC-125G	10-slot full-size compact chassis
RACK-3400G	4U 10-slot half-size rack-mount chassis

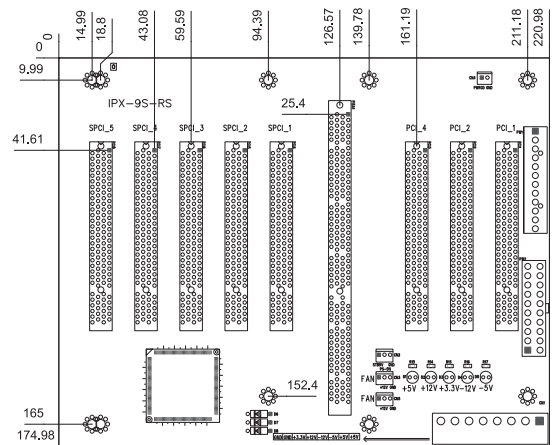

IP-10S-RS-R40

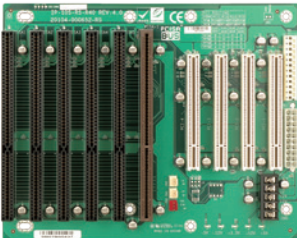

Ordering Information

IP-10S-RS-R40	10-slot backplane with 4 PCI slots and 5 ISA slots
PAC-125G	10-slot full-size compact chassis
RACK-3400G	4U 10-slot half-size rack-mount chassis

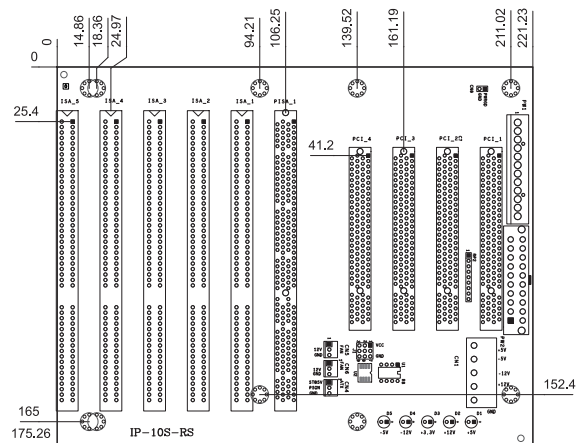

IPX-13S-RS-R40

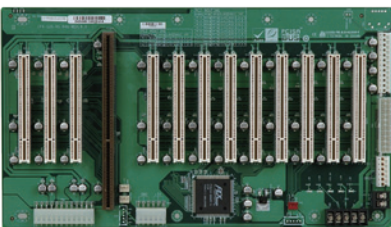

Ordering Information

IPX-13S-RS-R40	13-slot backplane with 12 PCI slots
RACK-305G	4U 14-slot rack-mount chassis
RACK-360G	4U 14-slot rack-mount chassis
RACK-3000G	4U 14-slot rack-mount chassis

